

Data Sheet



Article number: 021816011089

Description: Clamp with bracket and rubber
SPGU 6011. 89/30 SK

Measures

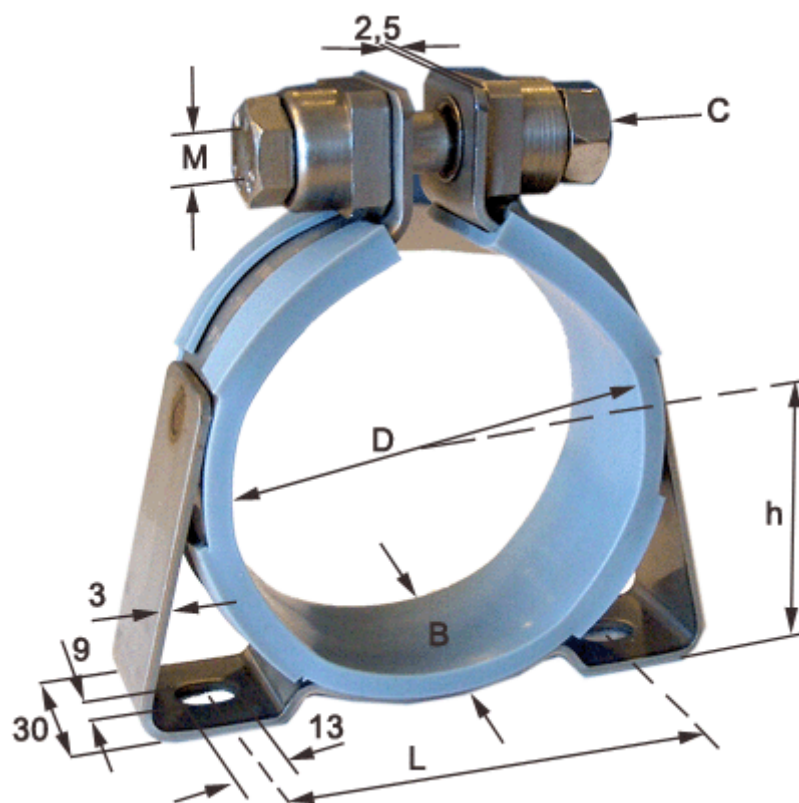

C (screw type) = SK hexagon screw

Diameter D = 89

h = 53

L = 82

Width B = 30